

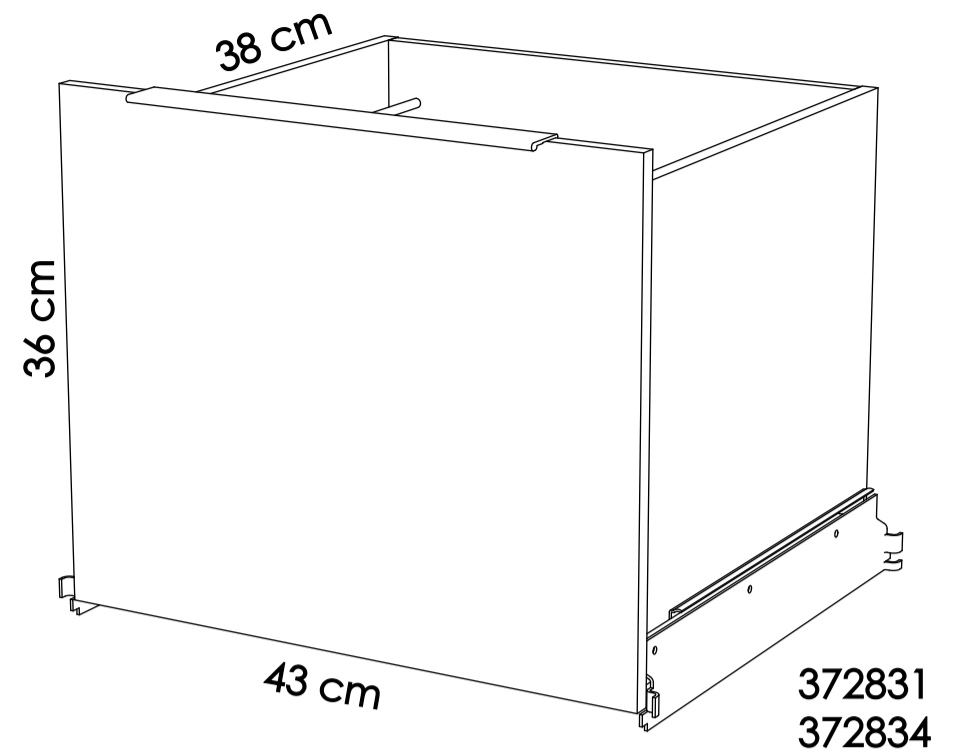

BALTON®

B III

372831
372834

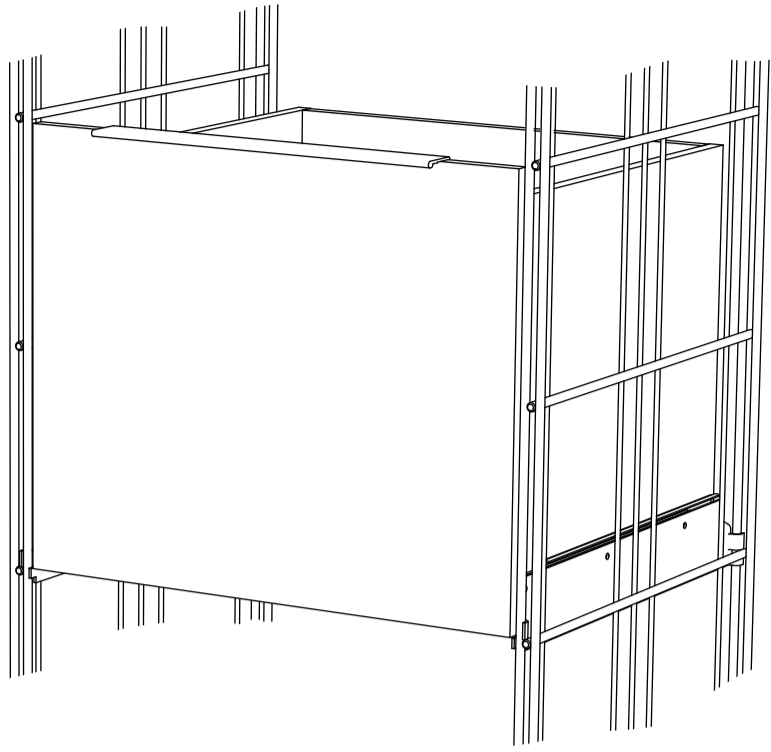

 Unos consejos

Después de unas semanas se debe de controlar y asegurar de nuevo los tornillos y bulones. Para la limpieza se recomienda utilizar solamente agua detergente de jabón suave. Seque con un trpo seco suave. Otros métodos de limpieza pueden causar danos que la garantía no cubre.

 Noch einige gute Tips

Nach ungefähr einer Woche sollten die Schrauben und Bolzen überprüft und nachgezogen werden. Die Reinigung erfolgt nur mit wasser und milder Seifenlauge, anschliessend mit einem weichem Lappen trockenreiben. Andere Reinigungsmethoden bzw.- mittel können Schäden verursachen, für die der Hersteller nicht haftet.

 Some useful advice

You should check and re-tighten the screws and bolts a few weeks after assembly. For Cleaning, use mild soapy water only and dry with a soft cloth. Other cleaning agents may cause damage not covered by the warranty.

 Quelques bons conseils

Après quelques semaines, il convient de contrôler et de serrer à nouveau les vises et les boulons. Pour le nettoyage, utilisez de l'eau savonneuse douce. Essuyez avec un chiffon doux. D'autres méthodes de nettoyage peuvent causer des dommages non-couverts par la garantie.

 Instrucciones de montaje

DESCRIPCIÓN DEL PRODUCTO:
Fabricado en Suecia.

 Montageanleitung

PRODUKTBESCHREIBUNG:
Hergestellt in Schweden.

 Assembly instructions

PRODUCT DESCRIPTION:
Made in Sweden.

 Instructions de montage

DESCRIPTION DU PRODUIT:
Fabriquée en Suède.

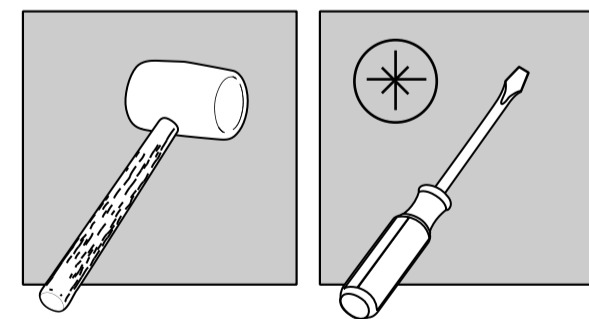
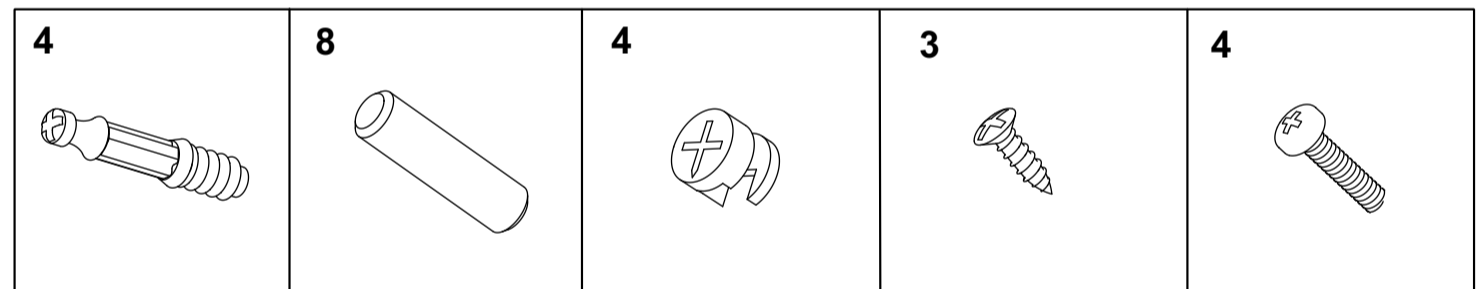
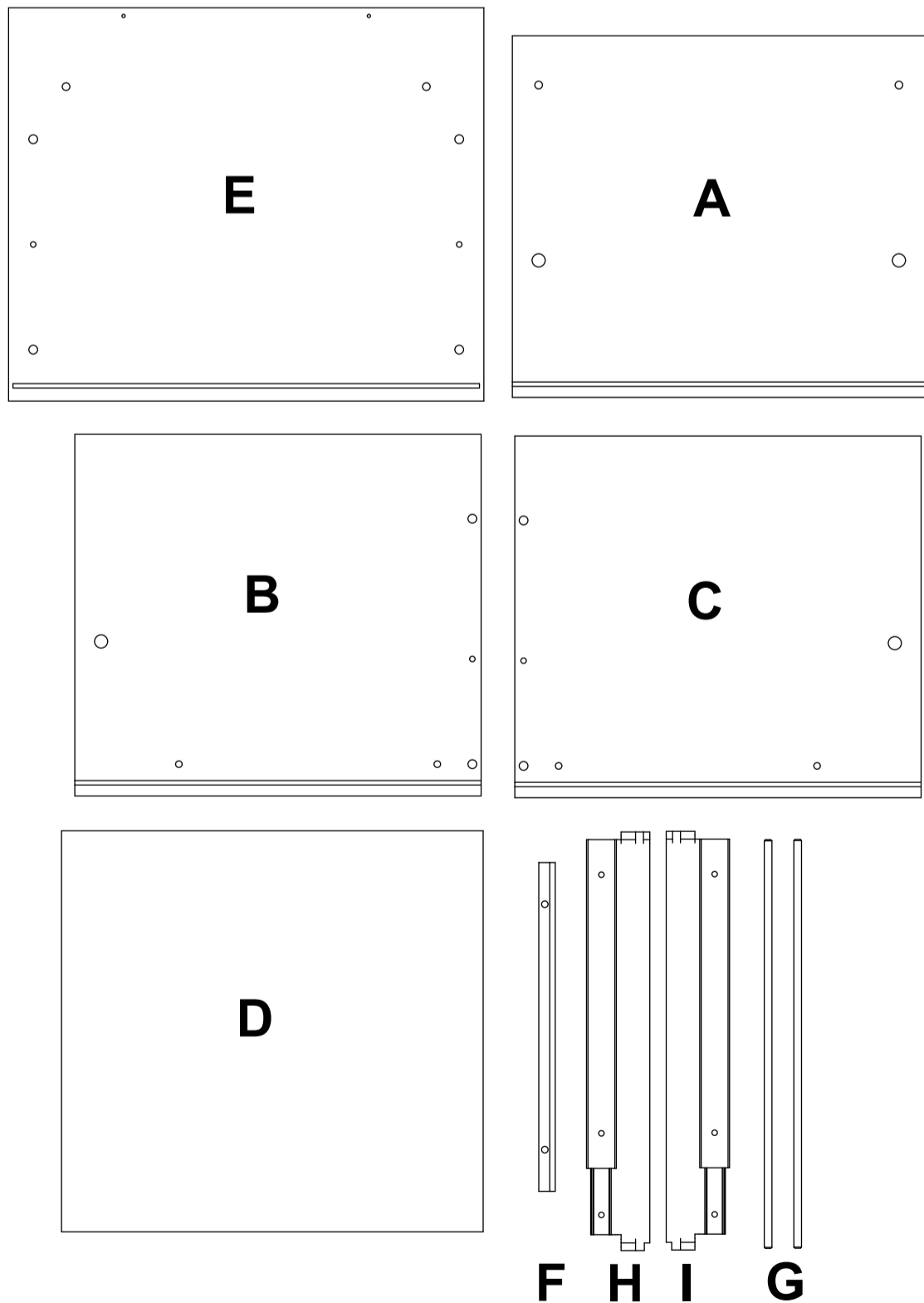

 Antes del montaje

Lea cuidadosamente las instrucciones antes de empezar el montaje. Controle el contenido del embalaje. Pongase en contacto con su distribuidor si encuentra algo deficiente o que las herramientas están disponibles. Efectue el montaje paso a paso según el manual.

 Vor der Montage

Lesen Sie bitte als erstes die Montageanleitung sorgfältig durch. Überprüfen Sie den Verpackungsinhalt. Falls teile fehler oder defekt sind, setzen Sie sich bitte mit Ihrem fachhändler in Verbindung. Achten Sie darauf, dass die schraffiert dargestellten Werkzeuge bereitliegen. Die montage erfolgt schrittweise gemäss Anleitung.

 Before assembly

Read through the instructions carefully before starting assembly. Check the contents of the package. Contact the point of sale if you find anything defective or missing. Make sure that the shaded tools are available. Assemble step by step as shown in the instructions.

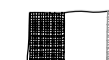
 Avant le Montage

Lisez attentivement les instructions avant de commencer les travaux de montage. Contrôlez le contenu de l'emballage. En cas de pièces endommagées ou manquantes, contactez le point de vente. Assurez-vous que les outils nécessaires sont disponibles. Effectuez le montage étape par étape suivant les instructions.

